



Digital Radio Tester CTS for mobile phones

GSM 900/1800/1900
and DECT

Tester family for fast and conclusive GSM and DECT measurements in service

Compact, modular testers

- Fast and precise measurements for service and adjustment
- Brilliant TFT colour display
- Menus in six different languages
- Connectors for external monitor and keyboard to make operation even more convenient
- Problem-free upgrading of existing units

for GSM900/1800/1900

- Measurements to GSM recommendations
- Quick test (fast go/nogo test)
- Versatile autotest
- Manual test for exact fault location
- Module test (RF measurements without signalling)
 - burst analysis
 - RF generator
 - narrowband spectrum monitor
- Windows™ application program for customized autotest

... and DECT

- Measurements to CTR06
- Configurable autotest
- Manual test for exact fault location
- Off-air measurements via sensitive input and power output
- Universal DECT frequency range



ROHDE & SCHWARZ

Testing a mobile is so easy

GSM and DECT measurements with one and the same tester

Digital Radio Tester CTS – a new tester family from Rohde&Schwarz – comes in three models:

- **CTS55**
for mobile phones to GSM900/1800/1900
- **CTS60**
for DECT phones (portable part and fixed part)
- **CTS65**
for GSM and DECT

Fast automatic functional test ...

The automatic test routines of the CTS enable you to demonstrate the reliable functioning of a GSM or DECT mobile phone to the customer in a convincing manner. In case of complaints raised about mobiles, you will be able to show your technical competence: right in front of the customer the CTS detects whether the mobile is defective or whether the origin of the problems is to be sought elsewhere.

All under remote control

The Remote Control Option CTS-K6 provides remote control and individual automatic test runs (see page 9).

Convenient, ergonomic servicing

The CTS adapts itself to the user and not vice versa. Operation is extremely easy and does not require any special GSM or DECT knowledge. Functional tests can immediately be performed without any action being required from the user. Automatic test runs or manual test routines with a large variety of preset system-specific parameters are called up menu-driven via softkeys. The CTS immediately recognizes any input parameters that are not meaningful and limits them to the maximum permissible values. Inappropriate entries are thus largely excluded.

... and precise manual fault location

Additional manual measurement routines are provided to permit exact fault location on the basis of the conclusive results of the automatic test. The CTS allows in-depth measurements of bit error

rate, phase, frequency and modulation errors as well as analysis of timing and power ramp to be performed with great speed and high precision. The grounds for a perfect mobile radio service are thus well prepared.

Module test down to component level

Fitted with the GSM Module Test Option CTS-K7, the CTS provides additional functions allowing repairs down to the component level (see page 8).

Despite its great variety of test and measurement capabilities, the CTS follows one important principle: to encompass as many features as required and to keep them as simple as possible. The CTS is an ergonomically designed dedicated GSM/DECT mobile tester which presents the essential test parameters clearly and extremely user-friendly.

High-resolution colour display with outstanding brilliance

With its TFT colour display the CTS is exploring new grounds. The excellent brilliance and intensity are ideal prerequisites for eye-strain-free work even under adverse ambient illumination.



Digital Radio Tester CTS is an extremely compact, modular yet powerful measuring instrument. It combines great ease of operation and the necessary test depth for use in all service areas for mobile and cordless phones: from a simple functional test to repairs. Both the newcomer and the service specialist will be able to conveniently carry out fast automatic functional tests as well as complex and comprehensive manual measurements down to component level.



Sum of experience

Rohde&Schwarz, being one of the worldwide leading companies in the field of mobile radio measurements, was able to put its wide range of know-how and expertise into the development of type-approval systems such as the GSM system simulator and the extremely successful Digital Radiocommunication Tester CMD for production and service environments. This background was fully utilized in the development of the Digital Radio Testers CTS, service testers which are also fit for the measurement tasks of the future.



Digital Radio Tester CTS55 for GSM measurements



Digital Radio Tester CTS60 for DECT measurements

The CTS at a glance

- User-friendly menu-guided control via softkeys
- Logical user prompting without interleaved submenus
- Brilliant TFT colour display: a new dimension in this class of instruments
- Menus in six different languages
- Compact and robust design, low weight
- Eye-strain-free working
- Dynamic range for measuring the power ramp: GSM >55 dB, DECT >60 dB
- Built-in reference oscillator TCXO or OCXO (option CTS-B1)
- Combined RF input/output for GSM and DECT
- DECT off-air measurements via additional input/output
- Remote control via RS-232-C

Technical features in detail

Active TFT colour display

The high-resolution TFT colour display is outstanding for its brightness and extremely large viewing angle which is flexible for any requirement.

There are no reading problems due to reflections on the display or due to unfavourable light conditions (direct sun light).

Coloured menus provide additional means of clearly displaying the test results or highlighting important events such as out-of-tolerance conditions.

Flexible user interface

The CTS can be fully controlled via six softkeys and one hard-key. Maximum operating convenience is obtained by connecting an external PC keyboard. Individual keyboard drivers cater for country-specific keyboards. In addition to the TFT display, an external monitor can alternatively be connected via the VGA interface.

Results at a keystroke

The specific parameters of the networks and the mobile phones can be preset. An automatic test run which immediately produces conclusive results can be started simply at a keystroke.

For interference-free test results: universal shielded chamber

For measuring the receiver sensitivity of mobile phones, transmit levels below -90 dBm for DECT phones and even -100 dBm with GSM mobiles are required. The measurement may be impaired by external interference which occurs for instance in the immediate vicinity of base stations.

The Universal Shielded Chamber CTS-Z12 from Rohde & Schwarz ensures an interference-free measurement environment in all cellular mobile radio bands. It allows error-free measurement of the bit error rate (BER) as well as of the receiver parameters RxLev and RxQual of the mobile phone even under strong interference.

Functional testing of GSM mobiles is also possible via the Universal Antenna Coupler CTS-Z10 without an adapter cable. Antenna coupling in the 900 MHz, 1800 MHz and 1900 MHz bands is via the air interface and allows any fault in the antenna to be reliably detected.

All "cableless" couplers are sensitive to radiated interference and should therefore be effectively screened. The Universal Shielded Chamber CTS-Z12 has been optimized for use with the Universal Antenna Coupler CTS-Z10 and permits undisturbed measurements to be performed.

CTS ensures optimum interplay between the shielded chamber and the universal coupler. All essential parameters such as input and output coupling, adapter cable losses and other device-specific parameters can be stored in the CTS and recalled simply at a key-stroke.

GSM measurement, test and adjustment capabilities

- Synchronization of mobile phone with base station (which is simulated by CTS)
- Location update
- Call setup (incoming/outgoing)
- Call release (incoming/outgoing)
- Control and measurement of transmitter power
- Handover (channel change)
- Sensitivity
 - bit error rate BER and RBER
 - limit sensitivity via search routine
 - RxLev and RxQual
- Phase and frequency error
- Power ramp versus time
- Timing error
- AFC (automatic frequency correction) and RSSI (radio signal strength indication) with optional GSM Module Test CTS-K7
- I/Q modulator adjustment via narrowband spectrum monitor (option CTS-K7)
- Echo test (voice test, includes also testing of loudspeaker and microphone)
- Functional test of mobile's keypad through display of dialled number
- Display of
 - IMSI (international mobile subscriber identity)
 - IMEI (international mobile equipment identity)
 - power class
 - revision level
- Short message service (SMS)

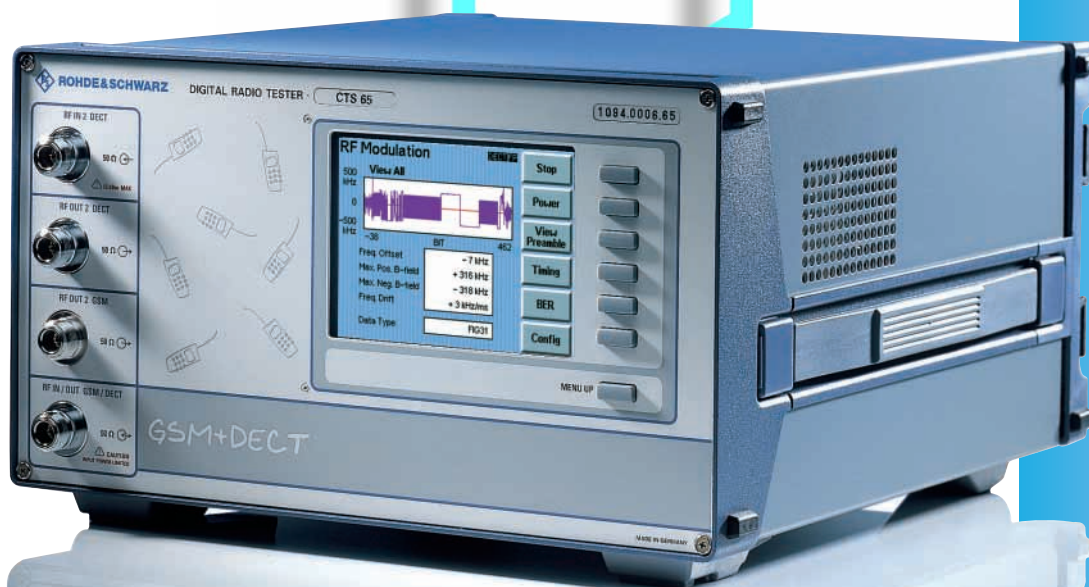

Digital Radio Tester CTS65 for GSM and DECT measurements

GSM measurements in detail

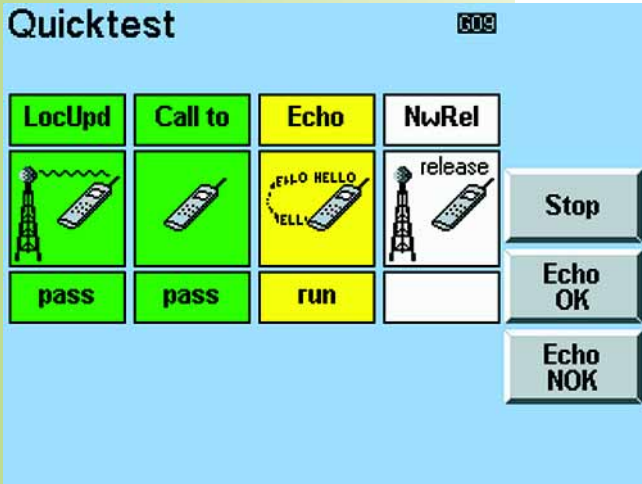

Quick test (1)

The quick test provides an extremely fast go/nogo information covering all essential parts of the mobile phone. A speech test (echo test) is carried out immediately after the call setup.

functions, the CTS checks the transmitter power of the different power classes and the receiver sensitivity by measuring the RxLev and RxQual parameters output by the mobile phone. A digital signal processor also enables measurement of the phase and frequency error, bit error rate and power ramp.

Versatile testing

The scope of measurements and hence the automatic test run time are variable: the user can decide whether he wants a short test or more in-depth testing. The number of channels or measured values can for instance also be adapted to the individual requirements.

Echo test

Speech received by the microphone of the mobile is sent to the CTS, stored in a buffer memory and sent back to the phone. In this way it is possible to check the whole signal path from the microphone via the RF transmitter/receiver section, modulator, demodulator, signalling section, speech coder/decoder, analog audio components to the loudspeaker. Measurement sequences and results are clearly displayed in graphical form.

Display modes

The individual results can be displayed as follows:

- as an OK/not OK statement in the Pass/Fail mode
- in full detail with accurate values in the Value mode, in tabular form on the display and, if desired, as a printout

The default tolerance values can be displayed in addition.

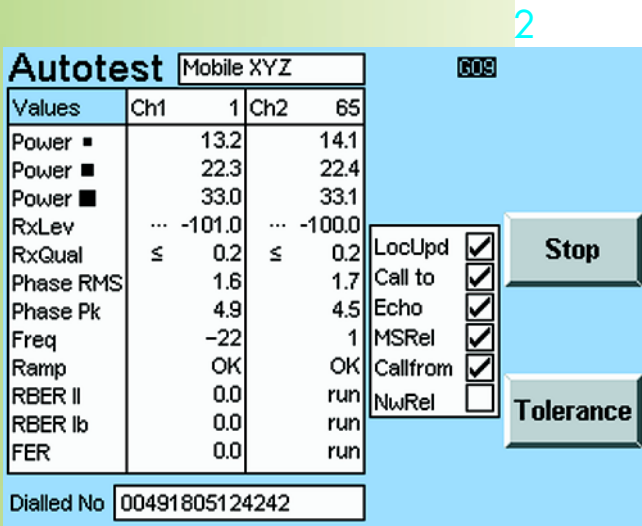

Manual test (6)

Digital Radio Tester CTS provides autotest routines as well as extensive manual test functions. Transmitter power and characteristic receiver parameters such as RxLev and RxQual are displayed. Moreover, the following signalling functions are available: location update, call setup and release by CTS or mobile. The dialled number as well as IMSI, IMEI, power class and revision level are indicated. The CTS also allows the transmission and reception of short messages SMS (point-to-point short message service).

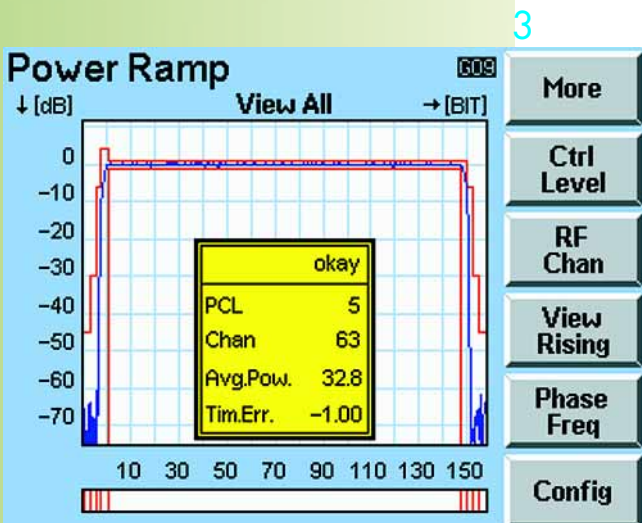

Autotest (2)

The autotest routines allow complete functional tests to be started at a keystroke. The tests cover all essential signalling functions as well as the transmitter and receiver characteristics of the mobile phone. In addition to the various signalling

GSM-specific RF measurements

Power ramp (3)

The power ramp can be measured by the CTS with a dynamic range of >55 dB and displayed in numerical or graphical form. In the graphical display mode the user can choose between overall view and partial view selected with the zoom function. The power ramp is evaluated with reference to the training sequence. Out-of-tolerance values are highlighted.

Phase and frequency error (4)

As soon as the training sequence is recognized, the CTS carries out these measurements in accordance with the GSM specifications. The results are displayed graphically and numerically.

Bit error rate (5)

The BER is an essential criterion for evaluating the receiver characteristics of the mobile phone. The CTS measures these characteristics with the aid of various test routines such as RBER (class Ib; II; FER) and BER (class Ib; II). A search routine allows fast and precise determination of the limit sensitivity of mobile phones.

Menus in six languages(6)

The multilingual CTS offers the user a choice of six working languages, ie English, German, French, Italian, Spanish and Dutch.

User-selectable network parameters (MCC, MNC, NCC, LAC)

The CTS is able to simulate any GSM network. This is of advantage if:

- the mobile is to be checked together with the SIM card of the network
- the test SIM card is not accepted by the mobile phone
- a test SIM card is not available

4

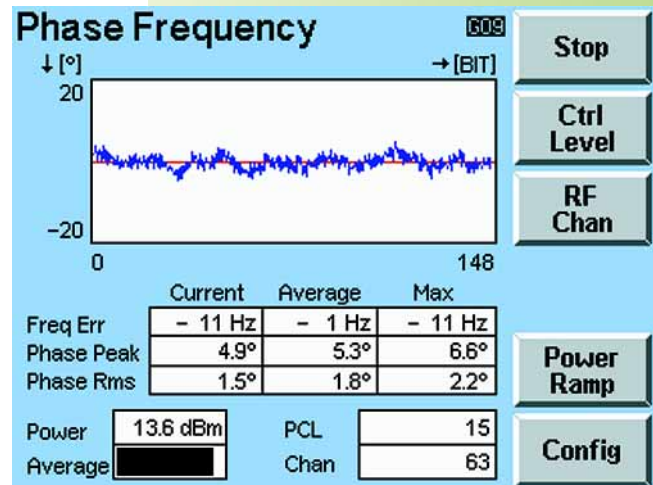

5

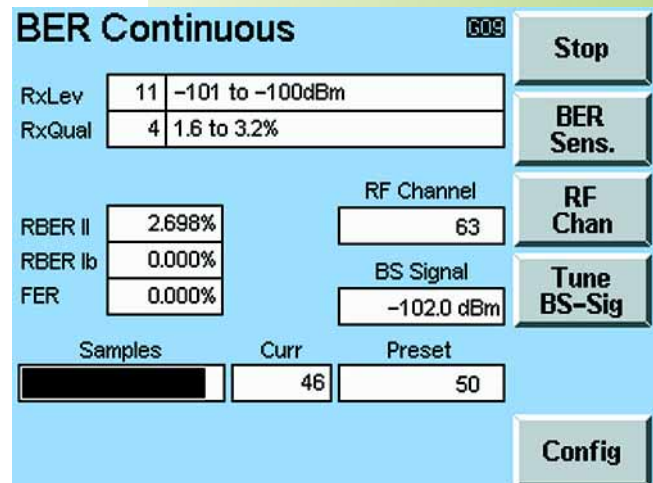

6

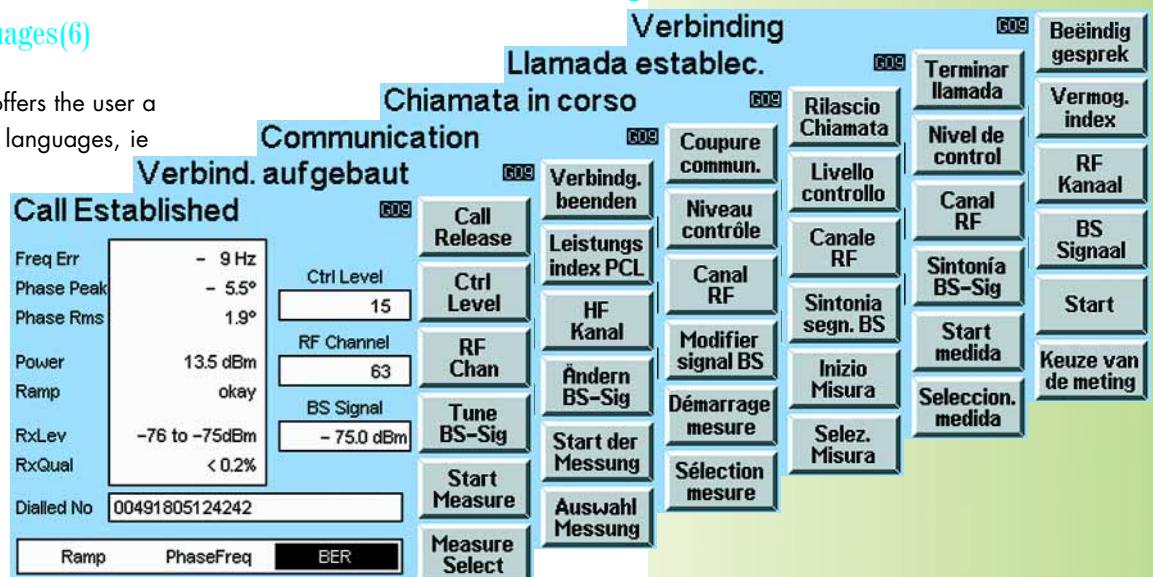

Testing at component level

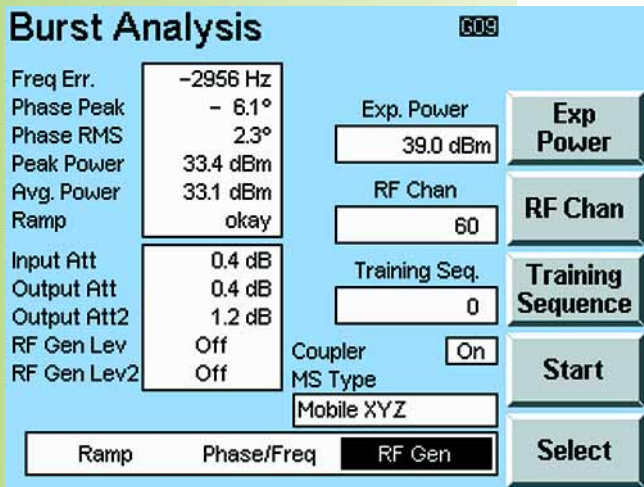

1

GSM module test (option CTS-K7)

The GSM module test provides additional functions allowing repairs down to the component level:

- burst analysis
- RF generator
- narrowband spectrum monitor for adjustment of the I/Q modulator

RF generator (2)

An independent RF generator generates GSM-specific signals which are required for adjustments such as AFC or RSSI. In addition to the typical modulation patterns (training sequence 0 to 7) a frequency offset corresponding to a permanent 0 or 1 modulation can alternatively be entered.

A second RF output enhances the power range of the CTS (RF OUT2, -15 dBm to -75 dBm).

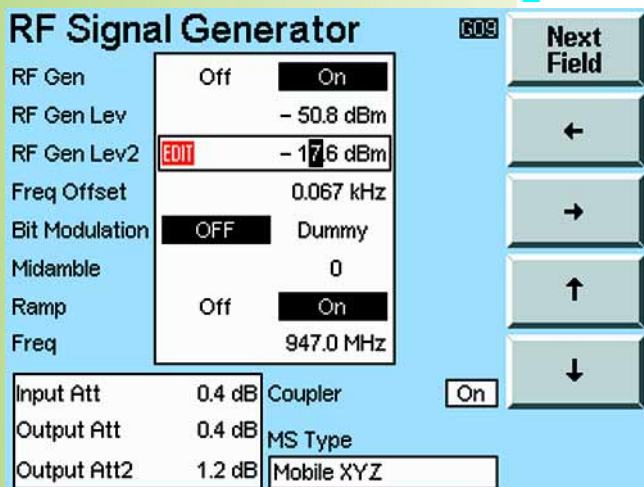

2

The mobile phone is set to a special service mode. Usually an external PC is used to control the mobile and trigger it to send. The CTS is then able to measure the RF parameters of the transmitter section without the signalling section of the mobile being required.

Narrowband spectrum monitor (3)

The narrowband spectrum monitor in the module test option allows fast and convenient adjustment of the I/Q modulator of mobile phones.

The menu is optimized for typical applications to ensure problem-free interplay with the existing software.

OCXO reference oscillator (option CTS-B1)

It ensures:

- excellent absolute accuracy
- minimum temperature-dependent drift
- especially high long-term stability (aging 0.2×10^{-6} /year)

In the service mode, the absolute frequency error of the mobile is measured rather than the error relative to the CTS. Since the stability of the reference oscillator directly influences the measurement accuracy, option CTS-B1 should be used for this application.

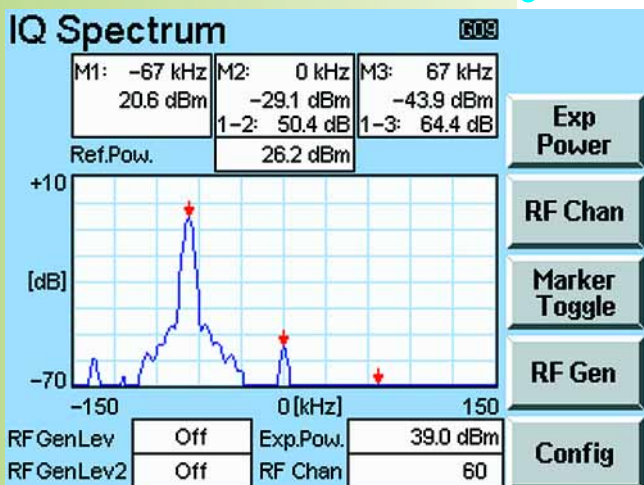

3

Burst analysis (1)

All characteristic test parameters of the transmitter such as output power or phase and frequency error are clearly displayed in a menu.

The CTS is able to recognize and analyze typical modulation patterns (training sequence, pattern 0 to 8).

All under remote control

Remote control (option CTS-K6)

Option CTS-K6 allows the CTS to be remote-controlled via the serial interface (RS-232-C). All settings of the manual test and module test can be called up via the RS-232-C interface and the results and displays read out. The Windows™ Application Program CTS-GO supplied with this option allows extremely fast and easy generation of individual automatic test runs. A test program with individual tolerance evaluation can be configured just with a few mouse clicks (1).

Individual tolerance values can be stored for each automatic test run. This affords maximum flexibility. Mobile-specific critical parameters can thus be taken into account by selecting appropriate tolerance values.

The test run can very easily be adapted with just a few mouse clicks and stored. Up to six different test sequences per test run can be defined. All RF measurements can be performed separately in each test sequence (2).

The CTS outputs the results in a measurement report (3). The results can also be stored in a PC for archiving or exported via data filters to other programs (eg Microsoft® Excel) for statistical evaluation.

1

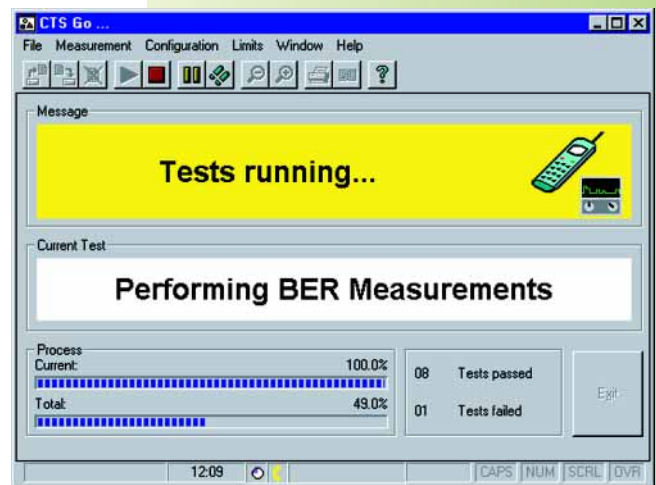

2



3

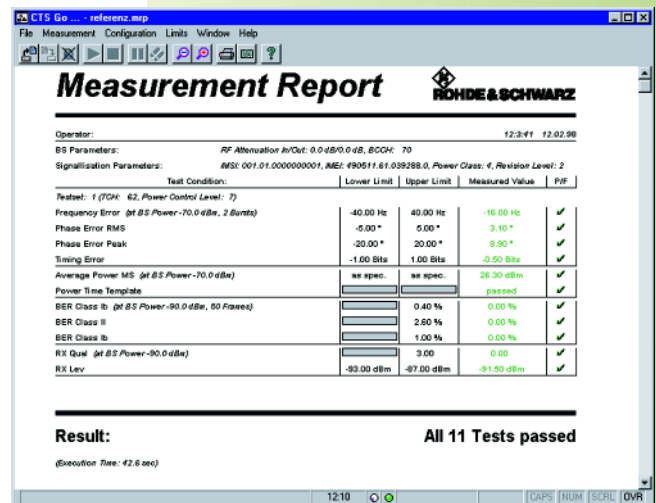

DECT measurements

Autotest DECTFP

02: Portable Part XYZ **Abort**

Action/Parameter	Value	Result
(01) Timing:		
Timing Accuracy	2.2 pp	Pass
MaxPosJitter	0.0 us	Pass
MaxNegJitter	-0.8 us	Pass
(02) Setup Connection		
Detected RFPI	0002EBOE0	
Dummy Slot	2	
Dummy Carrier	0	

1

DECT measurements with CTS60 and CTS65

These two CTS models provide DECT measurements on the fixed part (FP) and on the portable part (PP) in the service mode (CTRO6 mode). They measure the relevant RF parameters and check the standard signalling. Fast automatic functional tests as well as comprehensive manual measurements can of course be carried out.

the test run can be modified depending on the results, ie certain parts of the measurement can be repeated several times or not carried out at all.

Manual test (2)

Central test menu

Faulty functions detected in the automatic test can be exactly located by means of the manual test. A central test menu shows the main RF parameters at a glance. All further test routines are directly available in submenus.

Power ramp (3)

The CTS measures the power ramp of the signal sent by an FP or PP with a dynamic range of >60 dB. The power ramp is evaluated with reference to the PO bit and allows an accurate timing analysis of the signal in addition to the transmit power measurement. Out-of-tolerance values are quickly and precisely determined with the aid of zoom functions and colour highlighting.

RF modulation (4)

In the RF modulation menu the demodulated signal is graphically displayed in an oscilloscope window in order to allow simple and fast detection of typical data patterns with the aid of various zoom functions. Characteristic modulation parameters can be measured and numerically displayed for the data patterns "Figure 31; 01010101, 00001111".

Autotest (1)

DECT autotests can simply be generated and started at the push of a button.

Each individual function, eg call setup or power measurement, is available as a test step. Tolerance limits for the OK/not OK statement are separately stored for each macro and allow an individual configuration. With the aid of conditional branching

Connection Estab. DECTPP

NTP 23.9 dBm **Bearer Release**

Power Ramp okay **Power**

Freq. Offset - 16 kHz **RF Mod**

Max. Pos. B-field Mod. + 348 kHz **Timing**

Max. Neg. B-field Mod. - 348 kHz **BER**

Traffic Slot 2 **Number of Bursts**

Traffic Carrier 0

RF Level - 73.0 dBm

PMID FE689

No. of Bursts 4

2

Power Ramp DECTPP

↓ [dB] **View Useful** → [BIT]

ok

Traffic Slot 2

Traffic Carrier 0

NTP 24.0 dBm

0 50 100 150 200 250 300 350 400

More

View Falling

RF Mod

Timing

BER

Config

3

Bit error rate (6)

The bit error rate measurement furnishes reliable information about the receiver characteristics in the FP or PP. The CTS measures the bit and frame error rate (BER, FER) and displays both the current measured value and a statistical value averaged over a defined number of frames.

To obtain DECT measurements of highest accuracy, an OCXO reference oscillator (option CTS-B1) should be used (page 8).

- DECT measurement, test and adjustment capabilities**
- Synchronization of DUT with the CTS
 - Call setup
 - Call release
 - Echo test
 - Detection and display of RFPI (FP)
 - Normal transmit power (NTP)
 - Power ramp versus time
 - Modulation characteristics versus time
 - Frequency offset
 - Maximum modulation deviation
 - Frequency drift
 - Timing (jitter, packet delay)
 - Bit error rate (BER), frame error rate (FER)

4

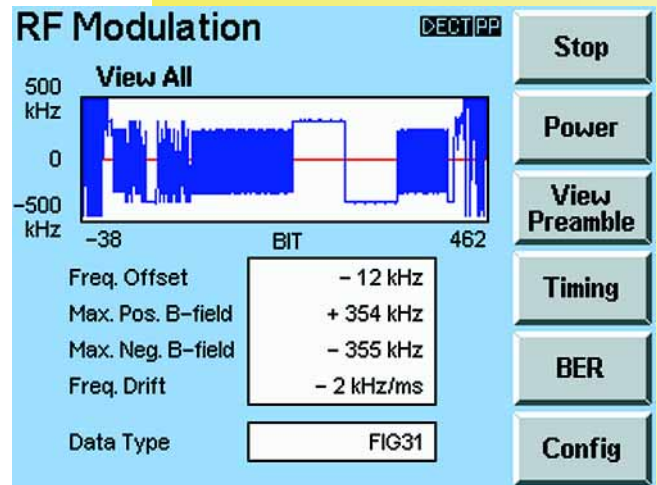

5

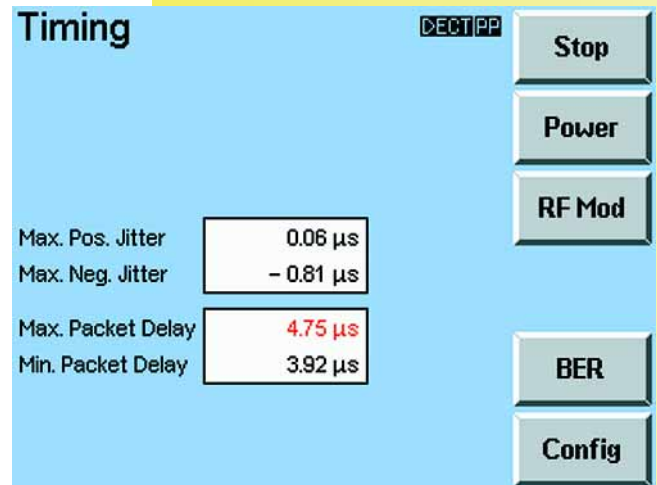

6

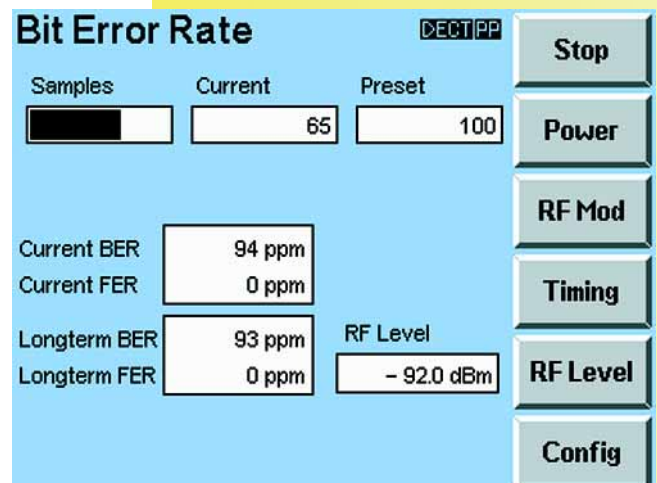

Specifications

Common data

Built-in reference oscillator	standard
Frequency drift in temperature range +5 °C to 40 °C	$\leq 1 \times 10^{-6}$
Aging	$\leq 0.5 \times 10^{-6}$ /year at 35 °C
OEXO reference oscillator	option CTS-B1
Frequency drift in temperature range +5 to +40 °C	$\pm 0.1 \times 10^{-6}$
Aging	$\leq 0.2 \times 10^{-6}$ /year at 35 °C

GSM

GSM signal generator	
Frequency range	GSM900 band 935 MHz to 960 MHz GSM1800 band 1805 MHz to 1880 MHz GSM1900 band 1930 MHz to 1990 MHz
Resolution	GSM channel spacing 200 kHz
Output level	
RF IN/OUT	
with 0 dB ext. attenuation	-50 dBm to -110 dBm
RF OUT2 GSM	
with 0 dB ext. attenuation	-20 dBm to -75 dBm
Level error	RF IN/OUT ≤ 1.5 dB RF OUT2 GSM ≤ 2.0 dB
Modulation	GMSK, B x T = 0.3

Narrowband Spectrum Monitor Option CTS-K7	
Span	300 kHz
Resolution bandwidths	4/10/20/50/100 kHz
Dynamic range (P >5 dBm)	
$\Delta f = 0$ kHz to 30 kHz	typ. 35 dBc
$\Delta f = 30$ kHz to 150 kHz	typ. 50 dBc
Markers	3 markers and delta marker

GSM signal generator in Module Test Option CTS-K7	
Frequency offset	-100 kHz to +100 kHz
Resolution	approx. 33 Hz
Power ramp	CW, burst
Bit modulation	none/dummy burst (midamble 0 to 8)

GSM peak power meter	
Frequency range	GSM900 band 890 MHz to 915 MHz GSM1800 band 1710 MHz to 1785 MHz GSM1900 band 1850 MHz to 1910 MHz
Measurement range	
with 0 dB ext. attenuation	-15 dBm to +39 dBm (peak values up to 41 dBm)
with 15 dB ext. attenuation	0 dBm to +39 dBm (peak values up to 41 dBm)
Resolution	0.1 dB
Error with 0 dB ext. attenuation	
P >5 dBm	≤ 1 dB
-5 dBm < P \leq 5 dBm	≤ 1.5 dB
-15 dBm < P \leq -5 dBm	≤ 2 dB

GSM measurement of phase and frequency error	
Frequency range	GSM900 band 890 MHz to 915 MHz GSM1800 band 1710 MHz to 1785 MHz GSM1900 band 1850 MHz to 1910 MHz
Measurement mode	<ul style="list-style-type: none"> frequency error phase error (rms) and phase error (peak) current value, average value and maximum value over several bursts
Level range	-15 dBm to +39 dBm (peak values up to 41 dBm)
Internal phase error	
GSM900 band	<1.4° (rms) <4.5° (peak)
GSM1800/1900 band	<2.0° (rms) <5.5° (peak)
Frequency measurement uncertainty	<15 Hz + drift of timebase

GSM measurement of burst power	
Frequency range	GSM900 band 890 MHz to 915 MHz GSM1800 band 1710 MHz to 1785 MHz GSM1900 band 1850 MHz to 1910 MHz
Measurement modes	<ul style="list-style-type: none"> power ramp rms and peak power of burst full burst (view all) rising edge useful range falling edge zoom
Display modes	
Reference level for full dynamic range with 0 dB ext. attenuation	0 dBm to +39 dBm (peak values up to 41 dBm) ≥ 55 dB
Dynamic range (P >5 dBm)	≤ 1.5 dB + resolution
Total error of peak power measurement (P >0 dBm)	0.1 dB
Resolution	

DECT

DECT signal generator	
Frequency range	1876.608 MHz to 1935.360 MHz and half channels
Frequency drift	same as reference oscillator
Output level	
RF IN/OUT	-100 dBm to -40 dBm
RF OUT2 DECT	-40 dBm to 0 dBm
	(-20 dBm to 0 dBm if RF IN2 DECT is active)
	useable up to 5 dBm
Burst switch-off	>30 dB
Resolution	0.1 dB
Level error	
RF IN/OUT	≤ 1.5 dB
RF OUT2 DECT	≤ 2.0 dB
Modulation	GFSK (B x T = 0.5)
Modulation error	<5% (at 288 kHz frequency deviation)

DECT analyzer	
Frequency range	same as signal generator
Measurement range	with 0 dB external attenuation
RF IN/OUT	30 dBm to -30 dBm
RF IN2 DECT	-35 dBm to -55 dBm
FM demodulator	
Frequency range	0 kHz to 450 kHz
Resolution	1 kHz
DC offset	<3 kHz
Residual FM	
RF IN/OUT	<15 kHz, peak, 95% confidence (30 dBm to 5 dBm)
	<5 kHz, peak, 95% confidence (30 dBm to 15 dBm)
RF IN2 DECT	<15 kHz, peak, 95% confidence (-35 dBm to -55 dBm)
	<5 kHz, peak, 95% confidence (-35 dBm to -40 dBm)

Level meter	
Range	
RF IN/OUT	30 dBm to -30 dBm
RF IN2 DECT	-35 dBm to -55 dBm
Dynamic range	≥ 60 dB (for P = 24 dBm)
Resolution	0.5 dB
Accuracy	
RF IN/OUT	<1 dB + resolution (30 dBm to 5 dBm)
RF IN2 DECT	<2 dB + resolution (<5 dBm)
	<2 dB + resolution (-35 dBm to -51 dBm)
	<2.5 dB + resolution (<-51 dBm)

Specifications (continued)

Audio interface

Output	unbalanced
Range	558 mV, 300 Hz to 3 kHz
Output impedance	<10 Ω (R _L >2 kΩ)
S/N + THD	30 dB at max. level
Passband ripple	0.5 dB
Input	unbalanced
Range	80 mV, 300 Hz to 3 kHz
Input impedance	22 kΩ
S/N + THD	30 dB at max. level
Passband ripple	0.5 dB

DECT applications

Accuracy and stability of RF carrier	averaging 10 bursts
Error	<2 kHz + reference
Accuracy and stability of timing	<0.1 μs + reference
Error	<0.1 μs + reference
Modulation section 1, 2, 4	approx. 11 kHz with min. (202 kHz) permissible deviation
Error	approx. 13 kHz with max. (403 kHz) permissible deviation
Frequency drift	
Error	approx. 1 kHz/ms (over 200 bursts)
Transmit power	
Measurement accuracy	
RF IN/OUT	<1 dB + resolution (30 dBm to 5 dBm)
RF IN2 DECT	<2 dB + resolution (<5 dBm)
	<2 dB + resolution (-35 dBm to -51 dBm)
	<2.5 dB + resolution (<-51 dBm)
Power versus time	
Power measurement accuracy	
RF IN/OUT	<1 dB + resolution (30 dBm to 5 dBm)
RF IN2 DECT	<2 dB + resolution (<5 dBm)
	<2 dB + resolution (-35 dBm to -51 dBm)
	<2.5 dB + resolution (<-51 dBm)
Timing measurement accuracy	<0.1 μs + reference

General data

VSWR at all RF connectors	≤1.5
Rated temperature range	+5 °C to +40 °C
Operating temperature range	+5 °C to +45 °C
Storage temperature range	-25 °C to +60 °C
Electromagnetic compatibility	complies with requirements of European EMC Directives EN 50081-1 and EN 50082-1
Mechanical resistance	
Sine vibration	IEC 68-2-6, IEC 1010-1, VG standard 95332-24-A2, MIL-T-28800 D class 5
Random vibration	DIN 40046, IEC 68-2-34
Shock	MIL-STD-810 D, MIL-T-28800 D classes 3 and 5
Rel. humidity	IEC 68-2-3
Power supply	200 V to 240 V AC ±10%, 100 V to 120 V AC ±10%, 50 Hz to 60 Hz ±5%
Power consumption	approx. 60 W
Electrical safety	ENG 1010-1; IEC 1010-1, VDE 0411 Part 1
Dimensions (W x H x D)	319 mm x 177 mm x 350 mm
Weight	CTS55, CTS60 approx. 7.8 kg CTS65 approx. 8.8 kg

Ordering information

Order designation

Digital Radio Tester (GSM)	CTS 55	1094.0006.55
Digital Radio Tester (DECT)	CTS 60	1094.0006.60
Digital Radio Tester (GSM and DECT)	CTS 65	1094.0006.65

Options

OXC0 Reference Oscillator		
Aging 0.2 x 10 ⁻⁶ /year	CTS-B1	1079.0809.02
GSM Remote Control (with Application Software for Windows™)	CTS-K6	1079.2001.01
GSM Module Test ^{1) C}	TS-K7	1079.2501.02

Modification and upgrade kits

Upgrade CTS55 to CTS65 ¹⁾	CTS-U56	1079.1605.02
Upgrade CTS60 to CTS65	CTS-U65	1079.1705.02
Modification: new front panel with RF OUT2 on front	CTS-U7	1079.1805.02

Recommended extras

Universal Shielded Chamber	CTS-Z12	1079.1470.02
Antenna Coupler (for handheld telephones 900/1800/1900 MHz)	CTS-Z10	1079.1240.02
GSM Test SIM	CRT-Z2	1039.9005.02
DECT antenna (with N connector)		1086.3116.00
Compact Keyboard		
German	PSP-Z1	1091.4000.02
US	PSP-Z2	1091.4100.02
Production Calibration	DCV-1	0240.2187.08
Service Manual		1094.3405.24



...making the right connections.



DQS REG. NO 1954-04

¹⁾ CTS-U7 is required for units manufactured in May 1998 or before.

Fax Reply (Digital Radio Tester CTS)

- Please send me an offer
- I would like a demo
- Please call me
- I would like to receive your free-of-charge CD-ROM catalog
(including Test&Measurement Products +
Sound and TV Broadcasting)

Others: _____

Name: _____
Company/Department: _____
Position: _____
Address: _____

Country: _____
Telephone: _____
Fax: _____
E-mail: _____

